

EXHC

EXPLOSION-PROOF HOUSING

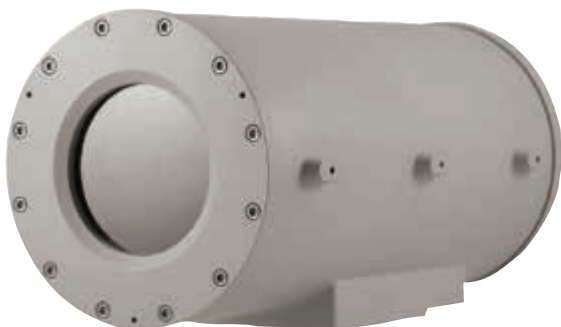

EXHC



EXHC + EXHS000

DESCRIPTION

The EXHC housings are made of a heavy-duty Anticorodal aluminium alloy and are designed to house video cameras installed in explosion-proof environments.

All the external components are powder-painted and guarantee excellent resistance against UV rays, marine environments and any polluting substances in the area of installation.

The cylindrical element of the housing is closed on opposite sides by two flanges and feature two holes for NPT 3/4" cable glands. The video camera housing is equipped with a triple heating element and an optional sunshield.

CERTIFICATIONS



MAIN FEATURES

Certifications Ex d for use in Zone 1 and 2, Group IIC (Gas), and in Zone Ex tb 21 and 22 (Dust)

Solid anticorodal aluminium construction

IP66

2 holes for cable glands 3/4" NPT

Supplied with heater. Sunshield as option.

Ambient temperature: from -40°C (-40°F) up to +50°C (122°F)

TECHNICAL DATA

MECHANICAL

Non-corrosive die-cast aluminium (anticorrosive)
Epoxy powder painted, RAL9002
Cable entry: 2 holes, 3/4" NPT
Internal dimensions: Ø 180x380mm (7.1x15in)
Internal usable dimensions: 100x100x280mm (3.9x3.9x11in)
Unit weight:
• 15kg (33.5lb)

HOUSING'S WINDOW

Window with extra clear tempered glass
• Usable diameter: 114mm (4.5in)
• Thick: 12mm (0.47in)

ELECTRICAL

Supply voltage/Current consumption (Ton 15°C±4°C (59°F±7°F), Toff 22°C±3°C (72°F±5°F)):
• 230Vac, 0.3A, 50/60Hz
• 24Vac, 2.5A, 50/60Hz
Power consumption
• Heater: 60W
• Installable camera: 20W max

CAMERAS

Characteristics of installable devices (cameras and lenses):
• Power consumption (assembly, camera and lens): 20W max
• Usable volume for camera/lens: 2800cm³
• Minimum distance between the walls of the housing and the camera/lens: 12mm

ENVIRONMENT

For indoors and outdoors installation
Operating temperature with heating: from -40°C (-40°F) up to +50°C (122°F)
Relative humidity: from 5% up to 95%

CERTIFICATIONS

Electrical safety (CE): EN62368-1
Electromagnetic compatibility (CE): EN61000-6-3, EN61000-3-2, EN61000-3-3, EN50130-4, EN55032 (Class B)
RoHS (CE): EN IEC 63000
Outdoor installation (CE): EN60950-22, IEC60950-22
IP protection degree (EN/IEC60529): IP66

CERTIFICATIONS - EXPLOSION-PROOF APPLICATIONS

ATEX (EN IEC 60079-0, EN 60079-1, EN 60079-31)
IECEX (IEC 60079-0, IEC 60079-1, IEC 60079-31)
EAC Ex (TR CU 012/2011)
UK Ex (EN IEC 60079-0, EN 60079-1, EN 60079-31)

For further details on certifications and markings, consult the relevant table.

BRACKETS AND ADAPTORS

WBLA Bracket and ball joint in solid anticorrosive aluminium construction, RAL9002

ACCESSORIES

EXHS000	Sunshield 580mm (22.8in) for EXH series
OCTEX3/4C	Cable gland in nickel-plated brass with gasket EX 3/4" NPT, unarmoured cable IECEX-ATEX-EAC Ex
OCTEXA3/4C	Cable gland in nickel-plated brass with gasket EX 3/4" NPT, armoured cable IECEX-ATEX-EAC Ex
OCTEXB3/4P	Barrier cable gland in nickel-plated brass EX 3/4" NPT, unarmoured cable IECEX-ATEX-EAC Ex
OCTEXBA3/4P	Barrier cable gland in nickel-plated brass EX 3/4" NPT, armoured cable IECEX-ATEX-EAC Ex
OCTEX3/4	Cable gland in nickel-plated brass with gasket EX 3/4" NPT, unarmoured cable ATEX
OCTEXA3/4	Cable gland in nickel-plated brass with gasket EX 3/4" NPT, armoured cable ATEX
OCTEXB1/2C	Barrier cable gland in nickel-plated brass EX 1/2" NPT, unarmoured cable IECEX-ATEX-EAC Ex
OCTEXB1/2P	Barrier cable gland in nickel-plated brass EX 1/2" NPT, unarmoured cable IECEX-ATEX-EAC Ex
OCTEXBA1/2P	Barrier cable gland in nickel-plated brass EX 1/2" NPT, armoured cable IECEX-ATEX-EAC Ex
OCTEX1/2C	Cable gland in nickel-plated brass EX 1/2" NPT, unarmoured cable IECEX-ATEX-EAC Ex
OCTEXS1/2C	Cable gland in nickel-plated brass EX 1/2" NPT, unarmoured cable IECEX-ATEX-EAC Ex
OCTEXA1/2C	Cable gland in nickel-plated brass EX 1/2" NPT armoured cable IECEX-ATEX-EAC Ex
OCTEX1/2-3/4P	Cable glands reduction in nickel-plated brass Ex 3/4" - 1/2" NPT IECEX-ATEX-EAC Ex
OCTEXP3/4C	Conduit cable gland nickel-plated brass 3/4" NPT IECEX-ATEX- c CSA us - EAC Ex (operating temperature: from -60°C (-76°F) up to +80°C (+176°F))
OEXPLUG1/2P	Plug EX 1/2" NPT IECEX-ATEX-EAC Ex
OEXPLUG3/4P	Plug EX 3/4" NPT IECEX-ATEX-EAC Ex

For further details about cable glands part numbers, please refer to the relevant table.

SPARE PARTS

OEXHFAV	Complete front flange with glass for EXH
OSLIEX03	Internal slide complete with heater for EXH series

PACKAGE

Model Number	Weight	Dimensions (WxHxL)	Master carton
EXHC003R	17.5kg (39lb)	61x32x31cm (24x12.6x12.2in)	-

CABLE GLANDS AND ACCESSORIES 1/2" NPT

Type	Certification	Operating temperature	Cable	Model Number	Maximum diameter of the external sheath (A)	Maximum diameter of the internal sheath (B)	Maximum diameter of the conductors bundle (C)
Barrier cable gland	IECEX/ATEX/EAC Ex	-60°C (-76°F) / +135°C (+275°F)	Unarmoured cable	OCTEXB1/2P	14.0mm (0.55in)	-	12.5mm (0.5in)
			Armoured cable	OCTEXBA1/2P	15.5 - 21.1mm (0.61-0.83in)	14mm (0.6in) max	12.5mm (0.5in)
Cable gland with gasket	IECEX/ATEX/EAC Ex	-60°C (-76°F) / +100°C (+212°F)	Unarmoured cable	OCTEX1/2C	3.2 - 8.0mm (0.12-0.31in)	-	-
			Unarmoured cable	OCTEXS1/2C	6.5 - 11.9mm (0.26 - 0.47in)	-	-
			Armoured cable	OCTEXA1/2C	12.5 - 20.5mm (0.49 - 0.8in)	10 - 14.3mm (0.4 - 0.56in)	-
Plug EX 1/2"NPT	IECEX/ATEX/EAC Ex	-100°C (-148°F) / +400°C (+752°F)	-	OEXPLUG1/2P	-	-	-

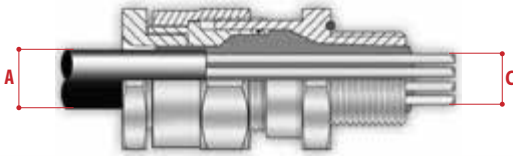

Barrier cable gland with unarmoured cable

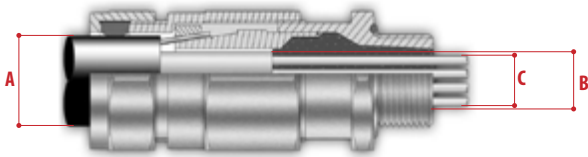

Barrier cable gland with armoured cable

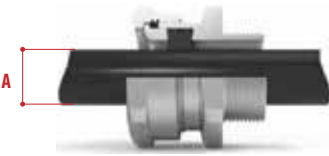

Cable gland with gasket with unarmoured cable



Cable gland with gasket with armoured cable

CABLE GLANDS AND ACCESSORIES 3/4" NPT

Type	Certification	Operating temperature	Cable	Model Number	Maximum diameter of the external sheath (A)	Maximum diameter of the internal sheath (B)	Maximum diameter of the conductors bundle (C)
Barrier cable gland	IECEX/ATEX/EAC Ex	-60°C (-76°F) / +135°C (+275°F)	Unarmoured cable	OCTEXB3/4P	20.0mm (0.78in)	-	17.8mm (0.7in)
			Armoured cable	OCTEXBA3/4P	16.8 - 23.9mm (0.66-0.94in)	20mm (0.79in) max	17.8mm (0.7in)
Cable gland with gasket	IECEX/ATEX/EAC Ex	-60°C (-76°F) / +100°C (+212°F)	Unarmoured cable	OCTEX3/4C	13.0 - 20.2mm (0.51-0.79in)	-	-
			Armoured cable	OCTEXA3/4C	16.9 - 26.0mm (0.66-1.02in)	11.1 - 19.7mm (0.44 - 0.78in)	-
	ATEX	-40°C (-40°F) / +100°C (+212°F)	Unarmoured cable	OCTEX3/4	14.0 - 17.0mm (0.55-0.67in)	-	-
			Armoured cable	OCTEXA3/4	18.0 - 23.0mm (0.71-0.91in)	14.0 - 17.0mm (0.55-0.67in)	-
Plug EX 3/4"NPT	IECEX/ATEX/EAC Ex	-100°C (-148°F) / +400°C (+752°F)	-	OEXPLUG3/4P	-	-	-
Conduit sealing fitting	IECEX-ATEX- c CSA us - EAC Ex	-60°C (-76°F) / +80°C (+176°F)	-	OCTEXP3/4C	-	-	11.0mm (0.43in)
Reduction 3/4" NPT x 1/2" NPT	IECEX/ATEX/EAC Ex	-100°C (-148°F) / +400°C (+752°F)	-	OCTEX1/2-3/4P	-	-	-

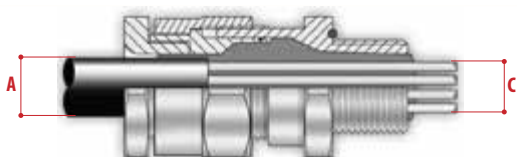

Barrier cable gland with unarmoured cable

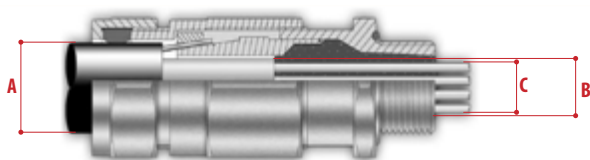

Barrier cable gland with armoured cable



Cable gland with gasket with unarmoured cable



Cable gland with gasket with armoured cable



Conduit sealing fitting

EXHC - CERTIFICATIONS AND MARKINGS

Part number	Certification	Marking	Ambient temperature	Cable input temperature
EXHC003R EXHC203R	ATEX	⊕ II 2 G Ex db IIC T6 Gb ⊕ II 2 D Ex tb IIIC T85°C Db	-40°C ≤ Ta ≤ +50°C	+80°C
	IECEx	Ex db IIC T6 Gb Ex tb IIIC T85°C Db		
	EAC Ex	1Ex db IIC T6 Gb X Ex tb IIIC T85°C Db X		
	UK Ex	⊕ II 2 G Ex db IIC T6 Gb ⊕ II 2 D Ex tb IIIC T85°C Db		

EXH - CONFIGURATION OPTIONS

	Voltage		Ambient temperature	Window
EXHC	0 24Vac	0	3 -40°C/+50°C	R Extra clear glass
	2 230Vac			

TECHNICAL DRAWINGS

The indicated measurements are expressed in millimetres.

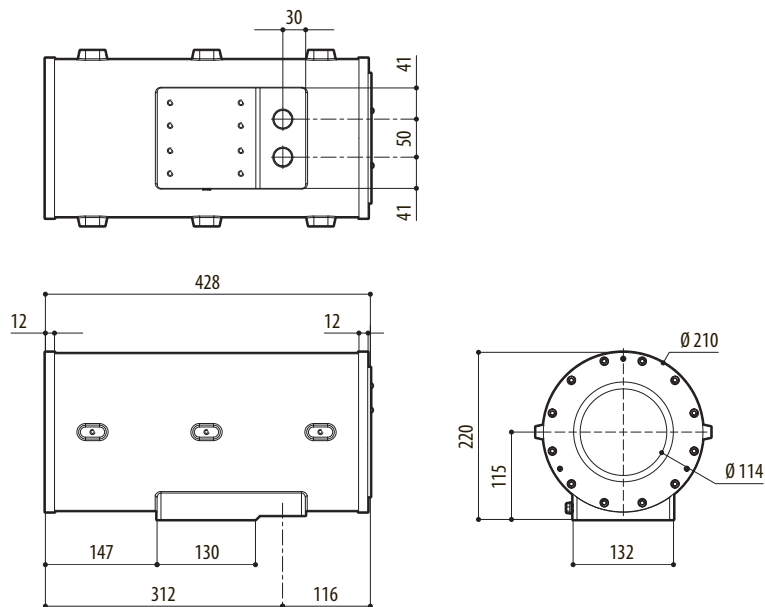

EXHC